

12	SEALING RUBBER	Pages
	Adhesive Backed Foam	2
	Sheet Edge Seal - Side Mount Seals	3 - 4
	Sheet Edge Seal - Top Mount Seals	4 - 5
	Sheet Edge Protection	5 - 8
	Window Sealing Rubber	8
	Truck / Container Door Seal & Corner Joiners	9

12 SEALING RUBBER



SEALING RUBBER

EDPM ADHESIVE FOAM

D SHAPE PROFILES



SEL-R-X codes are hollow



M-1300 codes are not hollow



9187STS

Hollow, with fins, 3M tape
Exceptionally good sealing



SEL-R-X1333HT

SEL-R-X105HT

SEL-R-X109HT

SEL-R-X119HT

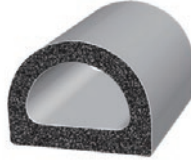

SEL-R-X135HT



M-1300.X.X



9187STS

Code	Dimensions	Order Qty
SEL-R-X1333HT	9.5W x 5.5mmH	Per m, or, 100m Roll
SEL-R-X105HT	9.5W x 11mmH	Per m, or, 76m Roll
SEL-R-X109HT	16W x 9.5mmH	Per m, or, 100m Roll
SEL-R-X119HT	19W x 9.5mmH	Per m, or, 100m Roll
SEL-R-X135HT	19W x 14mmH	Per m, or, 76m Roll
M-1300.5.10	10W x 5mmH	50m Roll
M-1300.5.15	15W x 5mmH	50m Roll
M-1300.8.15	15W x 8mmH	50m Roll
9187STS	20W x 17mmH	Per m, or, 50m Roll

RECTANGULAR PROFILES

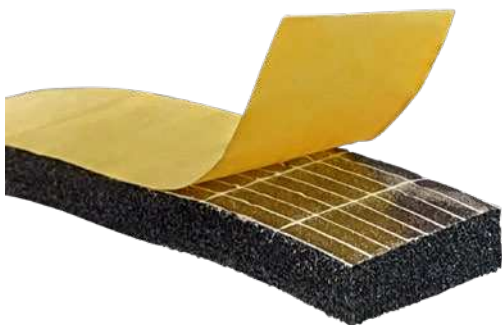

M-1200 codes

- Scrim netting for better resistance to overstretching
- High quality adhesive
- EDPM-Closed cell construction

Code	Dimensions	Order Qty
M-1200.2.10	2H x 10mmW	10m Roll
M-1200.3.10	3H x 10mmW	10m Roll
M-1200.3.15	3H x 15mmW	10m Roll
M-1200.3.20	3H x 20mmW	10m Roll
M-1200.3.30	3H x 30mmW	10m Roll
M-1200.5.10	5H x 10mmW	10m Roll
M-1200.5.20	5H x 20mmW	10m Roll
M-1200.5.25	5H x 25mmW	10m Roll
M-1200.5.30	5H x 30mmW	10m Roll
M-1200.5.40	5H x 40mmW	10m Roll
M-1200.6.12	6H x 12mmW	10m Roll
M-1200.6.20	6H x 20mmW	10m Roll
M-1200.6.25	6H x 25mmW	10m Roll
M-1200.10.15	10H x 15mmW	5m Roll
M-1200.10.25	10H x 25mmW	5m Roll

SEALING RUBBER

SIDE MOUNT SEAL

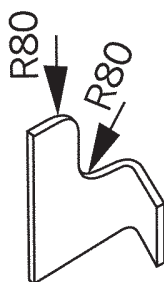
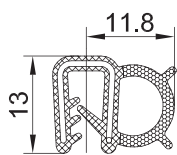

Code	Material	Grip Range	Order Qty
1011-106	EPDM	1.5 - 3.0mm	Per m, or 50m Roll

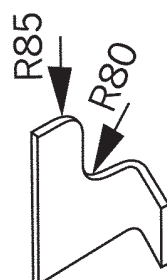
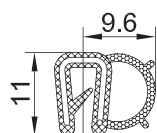

Code	Material	Grip Range	Order Qty
1011-109	EPDM	1.0 - 2.0mm	Per m, or 50m Roll

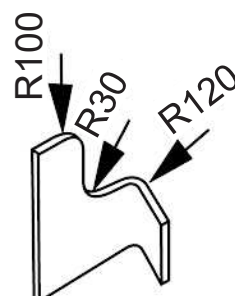
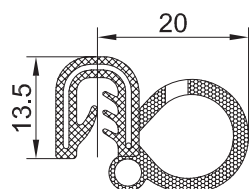

Code	Material	Grip Range	Order Qty
1011-A3297	EPDM	2.0mm	Per m, or 50m Roll

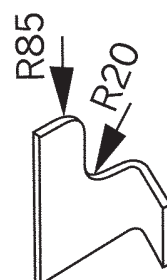
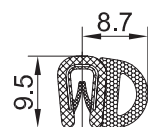

Code	Material	Grip Range	Order Qty
1011-10212	EPDM	1.0-2.0mm	Per m, or 100m Roll

SEALING RUBBER

SEALING RUBBER

SIDE MOUNT SEAL

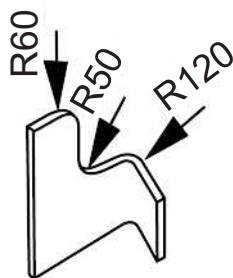
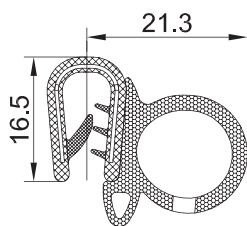

Code	Material	Grip Range	Order Qty
1011-A121/6	EPDM	4.0-6.0mm	Per m, or 50m Roll

TOP MOUNT SEAL

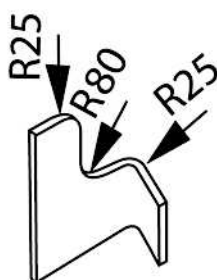
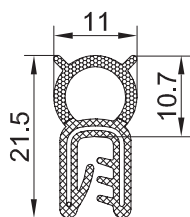

Code	Material	Grip Range	Order Qty
1011-105	EPDM	1.0-3.0mm	Per m, or 50m Roll

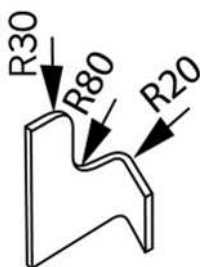
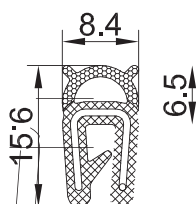

Code	Material	Grip Range	Order Qty
1011-110	EPDM	1.0-2.0mm	Per m, or 50m Roll

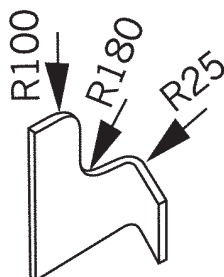
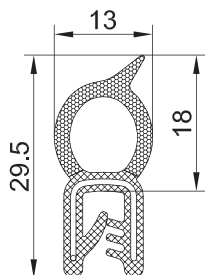

Code	Material	Grip Range	Order Qty
1011-A2516/4	EPDM	2.5-4.0mm	Per m, or 50m Roll

SEALING RUBBER

TOP MOUNT SEAL

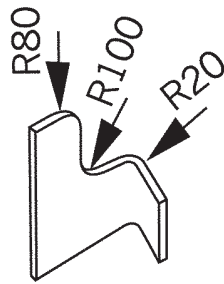
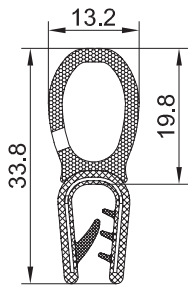

Code	Material	Grip Range	Order Qty
1011-A1104/4	EPDM	2.0-4.0mm	Per m, or 50m Roll

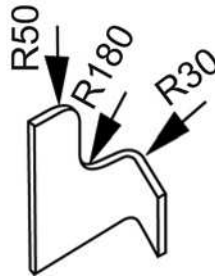
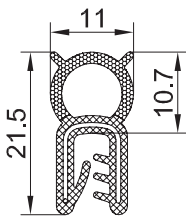

Code	Material	Grip Range	Order Qty
1011-A3681	EPDM	3.5-5.0mm	Per m, or 50m Roll

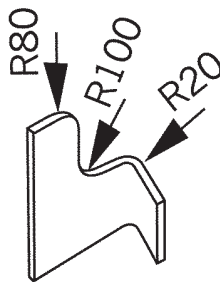
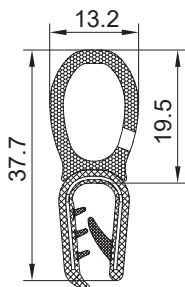

Code	Material	Grip Range	Order Qty
1011-A1030/E2583	EPDM	4.0-6.0mm	Per m, or 50m Roll

MARINE EDGE PROTECTION ALUMINIUM CAGE

- Suitable for marine applications
- Internal aluminium cage (no rust)
- Contact us for pricing and availability



SEALING RUBBER

EDGE PROTECTION

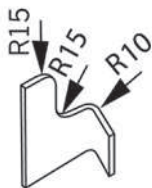
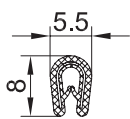

Code	Material	Grip Range	Order Qty
1011-10801	EPDM	0.8-1.5mm	Per m, or 100m Roll

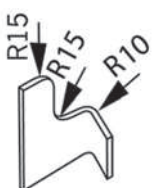
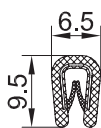

Code	Material	Grip Range	Order Qty
1011-10802	EPDM	1.0-2.0mm	Per m, or 100m Roll

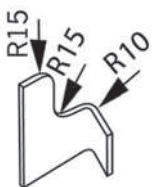
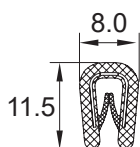

Code	Material	Grip Range	Order Qty
1011-10804	EPDM	1.0-3.0mm	Per m, or 100m Roll

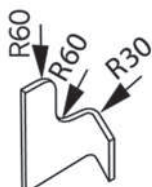
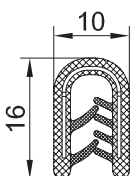

Code	Material	Grip Range	Order Qty
1011-10803	EPDM	1.0-4.0mm	Per m, or 100m Roll

SEALING RUBBER

EDGE PROTECTION

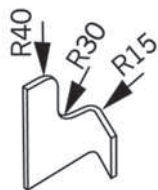
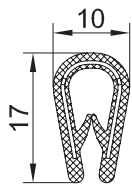

Code	Material	Grip Range	Order Qty
1011-A1018	EPDM	2.0-4.0mm	Per m, or 100m Roll

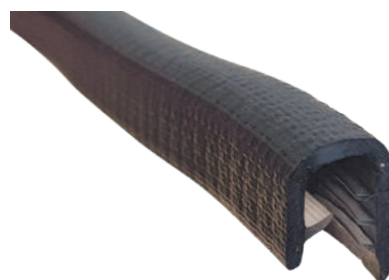
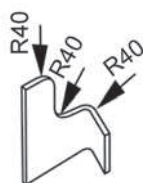
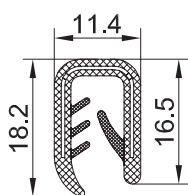

Code	Material	Grip Range	Order Qty
1011-A1030	EPDM	4.0-6.0mm	Per m, or 100m Roll

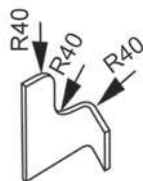
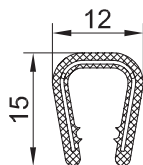

Code	Material	Grip Range	Order Qty
1011-A1019/8	EPDM	6.0-8.0mm	Per m, or 100m Roll

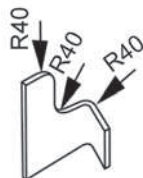
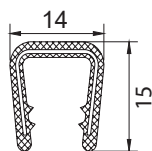

Code	Material	Grip Range	Order Qty
1011-A1019/10	EPDM	8.0-10.0mm	Per m, or 100m Roll

SEALING RUBBER

EDGE SEALING RUBBER

- Top mount sealing rubber
- EPDM material

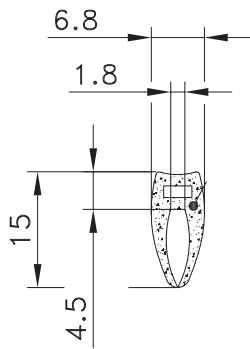

Example of application

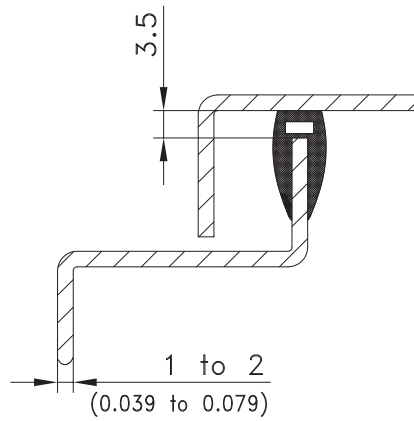

Code	Description
209-0302	EPDM Top mount sealing rubber

Other profiles available on request

WINDOW SEALING RUBBER

- Window sealing rubber
- EPDM material



Example of application

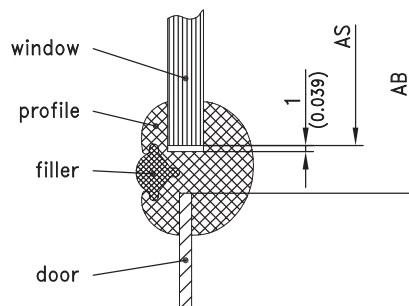

AS=size of window
AB=size of cutout

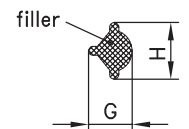
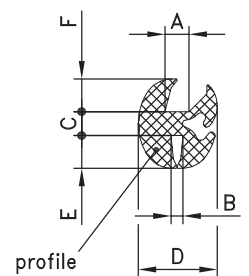

Code	Description	Units (mm)	A	B	C	D	E	F	G	H	Bend Radius
209-0502 + 209-0602	Profile + Filler		4	2.5	7	16	7	7	7.5	9.5	70

Other profiles available on request

SEALING RUBBER

TRUCK / CONTAINER SEAL

- Truck, trailer, container door sealing rubber supplied in 5m lengths
- Corner joiners available separately
- Glue with Sika or Quilosa MS35 product



P200-21 Grey H-Seal

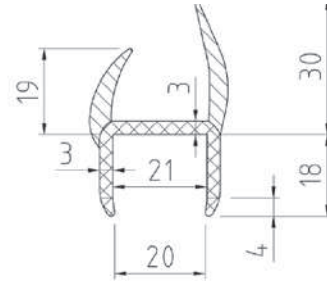

Code	Colour	Panel Thickness	Order Qty
P-200-21	Grey	20mm	5m



183020 Grey J-Seal

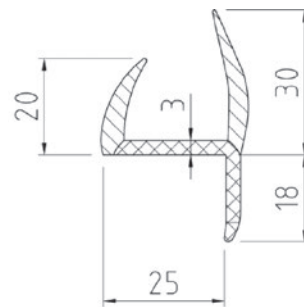

Code	Colour	Panel Thickness	Order Qty
183020	Grey	25mm +	5m
183125	Black	25mm +	5m



183125 Black J-Seal

CORNER JOINERS

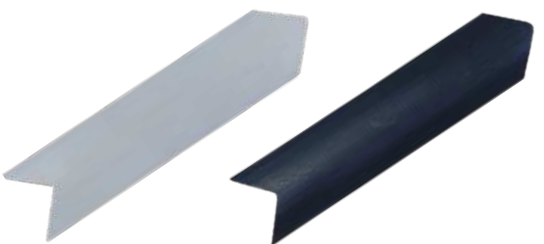

Showing 183020 mitre join without and with P2627 corner joiner

Code	Colour	Description
P2627	Grey	Corner Joiner
P2627-BLK	Black	Corner Joiner